

# Build Your Own Clone Scrambled Octave Kit Instructions

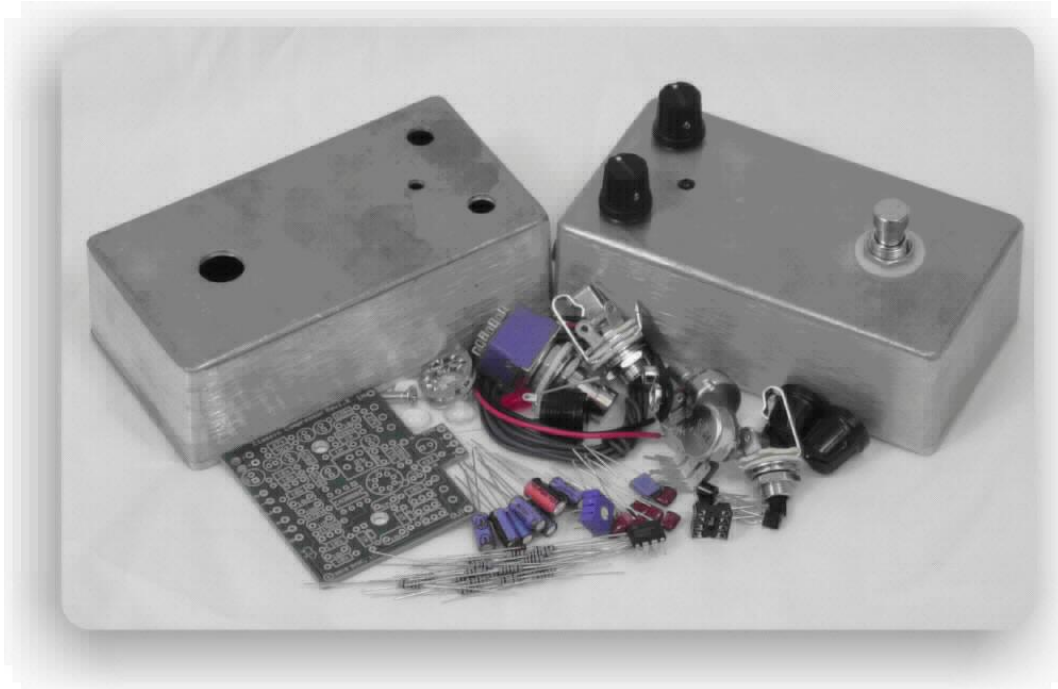

## **Warranty:**

BYOC, LLC guarantees that your kit will be complete and that all parts and components will arrive as described, functioning and free of defect. Soldering, clipping, cutting, stripping, or using any of the components in any way voids this guarantee. BYOC, LLC guarantees that the instructions for your kit will be free of any major errors that would cause you to permanently damage any components in your kit, but does not guarantee that the instructions will be free of typos or minor errors. BYOC, LLC does not warranty the completed pedal as a whole functioning unit nor do we warranty any of the individual parts once they have been used. If you have a component that is used, but feel it was defective prior to you using it, we reserve the right to determine whether or not the component was faulty upon arrival. Please direct all warranty issues to: [sales@buildyourownclone.com](mailto:sales@buildyourownclone.com) This would include any missing parts issues.

## **Return:**

BYOC, LLC accepts returns and exchanges on all products for any reason, as long as they are unused. We do not accept partial kit returns. Returns and exchanges are for the full purchase price less the cost of shipping and/or any promotional pricing. Return shipping is the customer's responsibility. This responsibility not only includes the cost of

shipping, but accountability of deliver as well. Please contact sales@buildyourownclone.com to receive a return authorization before mailing.

## **Tech Support:**

BYOC, LLC makes no promises or guarantees that you will successfully complete your kit in a satisfactory manner. Nor does BYOC, LLC promise or guarantee that you will receive any technical support. Purchasing a product from BYOC, LLC does not entitle you to any amount of technical support. BYOC, LLC does not promise or guarantee that any technical support you may receive will be able to resolve any or all issues you may be experiencing.

That being said, we will do our best to help you as much as we can. Our philosophy at BYOC is that we will help you only as much as you are willing to help yourself. We have a wonderful and friendly DIY discussion forum with an entire section devoted to the technical support and modifications of BYOC kits.

[www.buildyourownclone.com/board](http://www.buildyourownclone.com/board)

When posting a tech support thread on the BYOC forum, please post it in the correct lounge, and please title your thread appropriately. If everyone titles their threads "HELP!", then it makes it impossible for the people who are helping you to keep track of your progress. A very brief description of your specific problem will do. It will also make it easier to see if someone else is having or has had the same problem as you. The question you are about to ask may already be answered. Here are a list of things that you should include in the body of your tech support thread:

1. A detailed explanation of what the problem is. (not just, "It doesn't work, help")
2. Pic of the top side of your PCB.
3. Pic of the underside of your PCB.
4. Pic that clearly shows your footswitch/jack wiring and the wires going to the PCB
5. A pic that clearly shows your wiring going from the PCB to the pots and any other switches(only if your kit has non-PC mounted pots and switches)
6. Is bypass working?
7. Does the LED come on?
8. If you answer yes to 6 and 7, what does the pedal do when it is "on"?
9. Battery or adapter.(if battery, is it good? If adapter, what type?)

Also, please only post pics that are in focus. You're only wasting both parties' time if you post out of focus, low res pics from your cell phone.

## **Revision Notes:**

Rev 1.0 There are no known errors.

## **Copyrights:**

All material in this document is copyrighted 2011 by BYOC, LLC

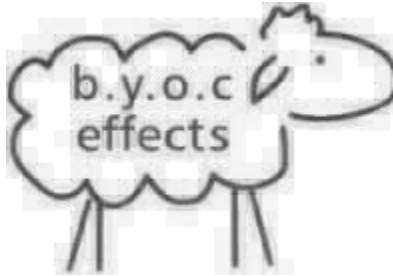

## **SCRAMBLED OCTAVE KIT INSTRUCTION INDEX**

<b>Parts Checklist.....</b>	<b>page 4 - 5</b>
<b>Populating the Circuit Board.....</b>	<b>page 6 - 13</b>
<b>Main PCB Assembly.....</b>	<b>page 14 - 17</b>
<b>Wiring.....</b>	<b>page 18 - 21</b>
<b>Operation Overview.....</b>	<b>page 22</b>
<b>Schematic.....</b>	<b>page 23 - 24</b>

## Parts Checklist for BYOC Scrambled Octave Kit

### Resistors:

- 1 - 220ohm (red/red/black/black/brown)
- 1 - 1k (brown/black/black/brown/brown)
- 1 - 2k2 (red/red/black/brown/brown)
- 3 - 4k7 (yellow/purple/black/brown/brown)
- 1 - 8k2 (gray/red/black/brown/brown)
- 1 - 10k (brown/black/black/red/brown)
- 2 - 47k (yellow/purple/black/red/brown)
- 2 - 220k (red/red/black/orange/brown)
- 1 - 470k (yellow/purple/black/orange/brown)
- 3 - 1M (brown/black/black/yellow/brown)

### Capacitors:

- 1 - 10n or .01 $\mu$  film (103)
- 2 - 1 $\mu$  aluminum electrolytic
- 3 - 4.7 $\mu$ f aluminum electrolytic
- 2 - 100 $\mu$ f aluminum electrolytic

### Diodes:

- 5 - 1N456 (small black plastic with a silver or white stripe)

### Transistors:

- 1 - BC169B
- 3 - 2N5306

**Potentiometers:** Be sure to snap off the small tab on the side of each panel mounted pot.

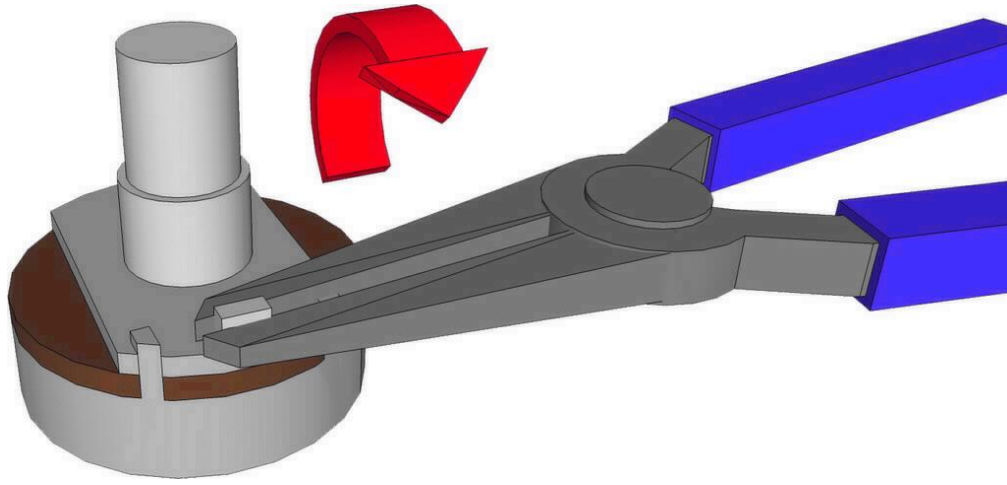

- 1 - B10k linear (TEXTURE)
- 1 - B50k audio (BLEND)

**Hardware:**

- 1 - drilled enclosure w/ 4 screws
- 1 - byoc classic Scrambled Octave PCB
- 1 - 3PDT footswitch
- 2 - knobs
- 1 - AC adaptor jack
- 1 - 1/4" mono jack
- 1 - 1/4" stereo jack
- 1 - red LED
- 1 - battery snap
- 4 - bumpers
- hook-up wire



for a larger pic, go to [www.buildyourownclone.com/scramblerguts.pdf](http://www.buildyourownclone.com/scramblerguts.pdf)

# Populating the Circuit Board

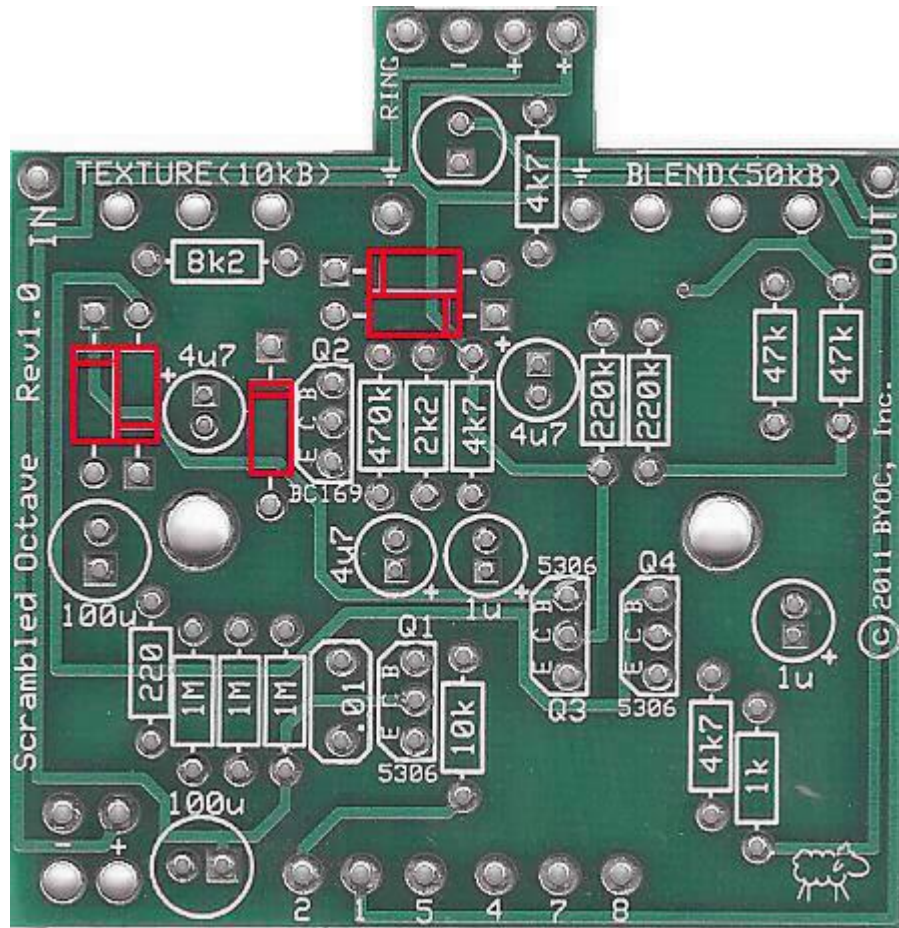

STEP 1: Add the diodes. Be sure to match the end of the diode with the stripe to the layout on the PCB. The stripped end should go in the square solder pad.

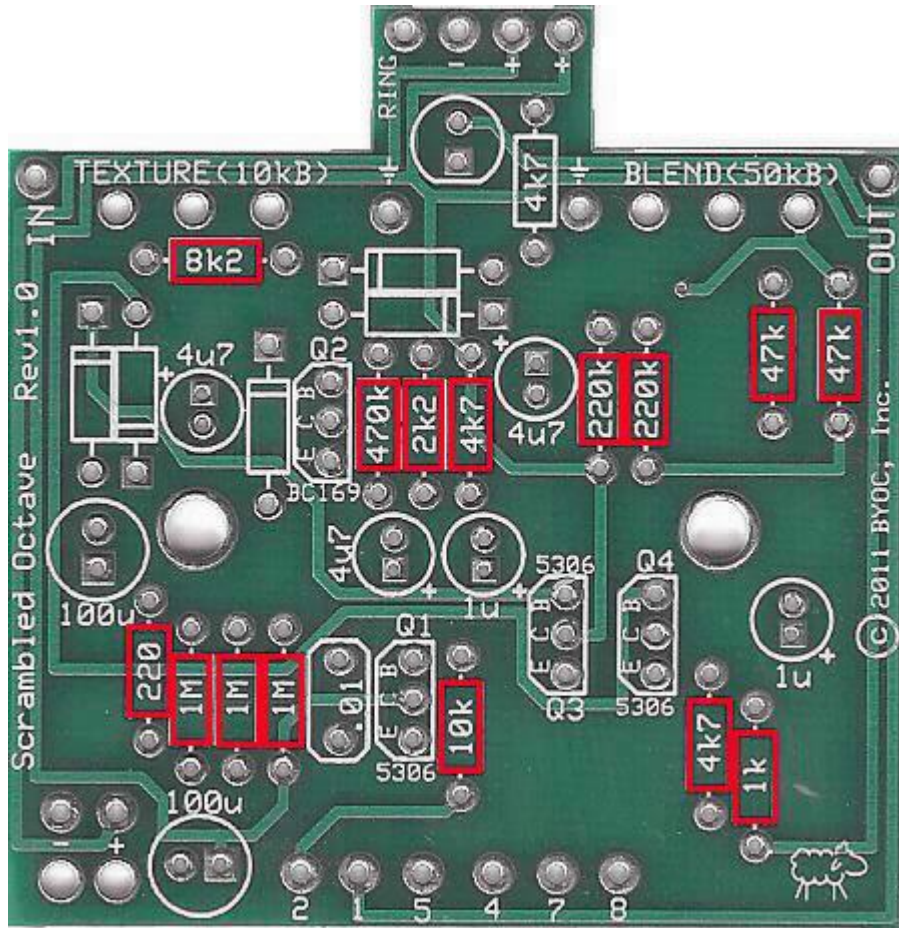

STEP 2: Add the resistors . Resistors are not polarized, so it does not matter which end goes in which solder pad. Take your time and be sure not to confuse similarly banded resistors such as the 470k with the 4k7 or the 220k with the 220 ohm. If you have difficulty reading the color bands, use a digital multimeter to test the value of each resistor.

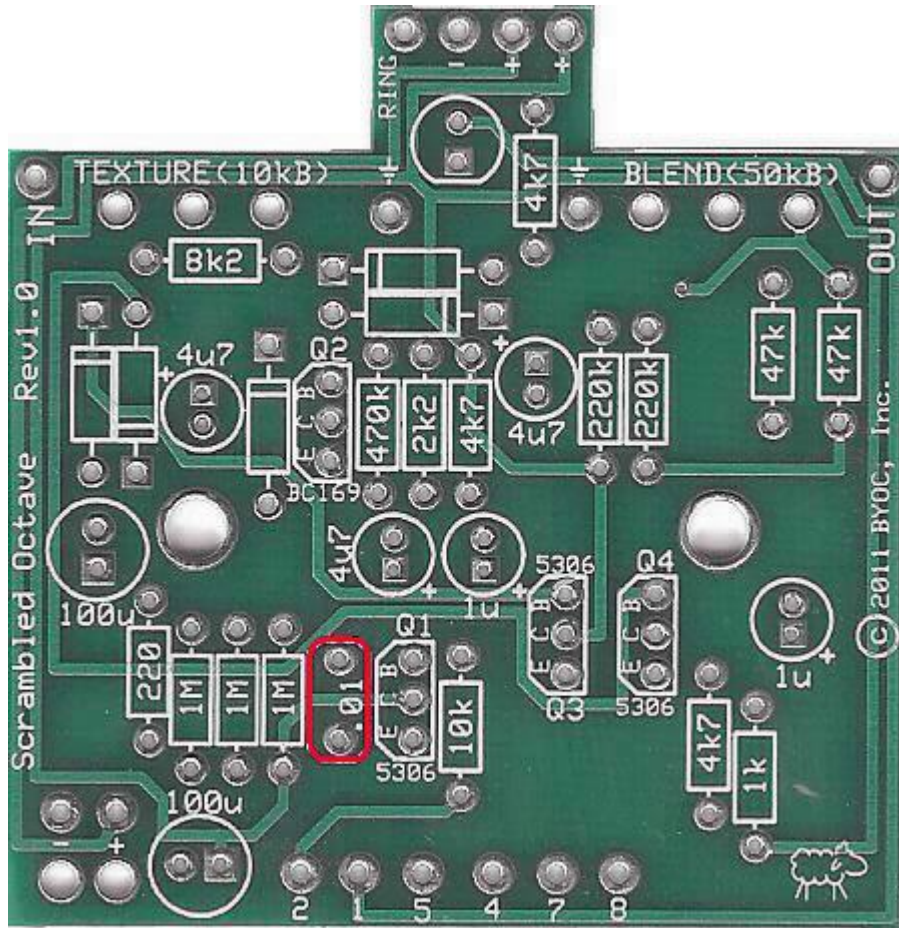

Step 3: Add the film capacitor. These are not polarized and can be inserted into the PCB either way.

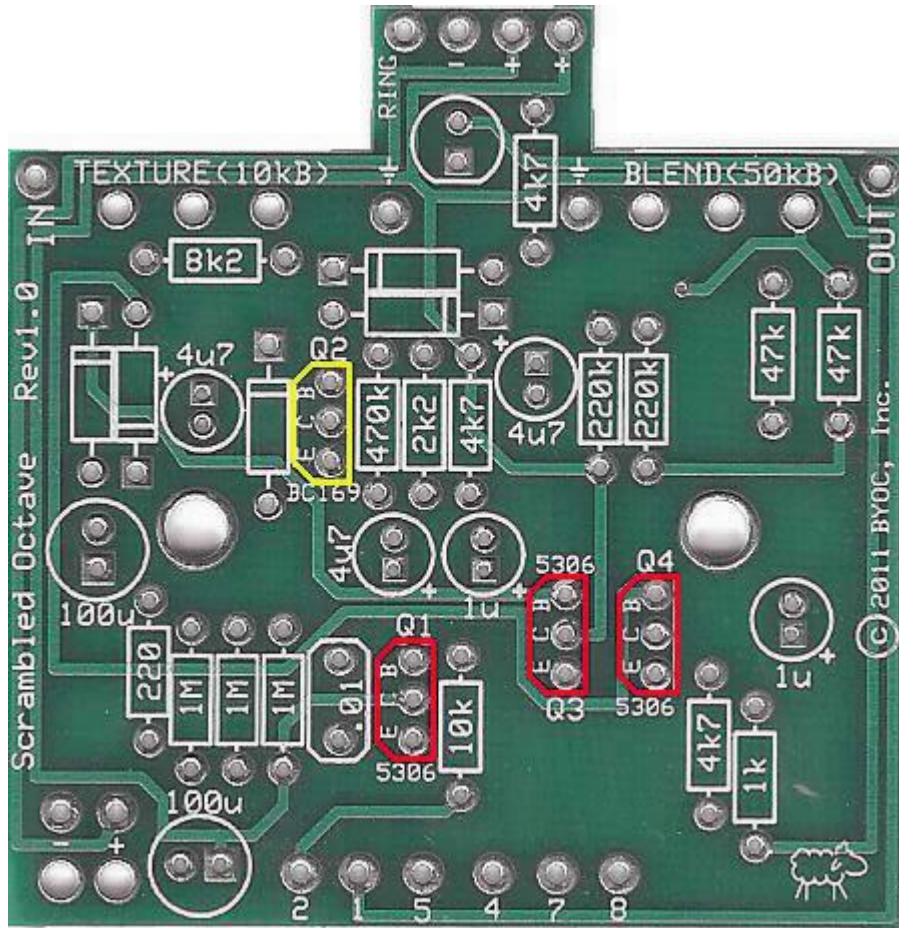

Step 4: Add the Transistors. Be sure to orient the transistor so that the flat side of the transistor body matches up with the flat side on the PCB layout. Make sure to insert the BC169B transistor into the Q2 space highlighted in yellow.

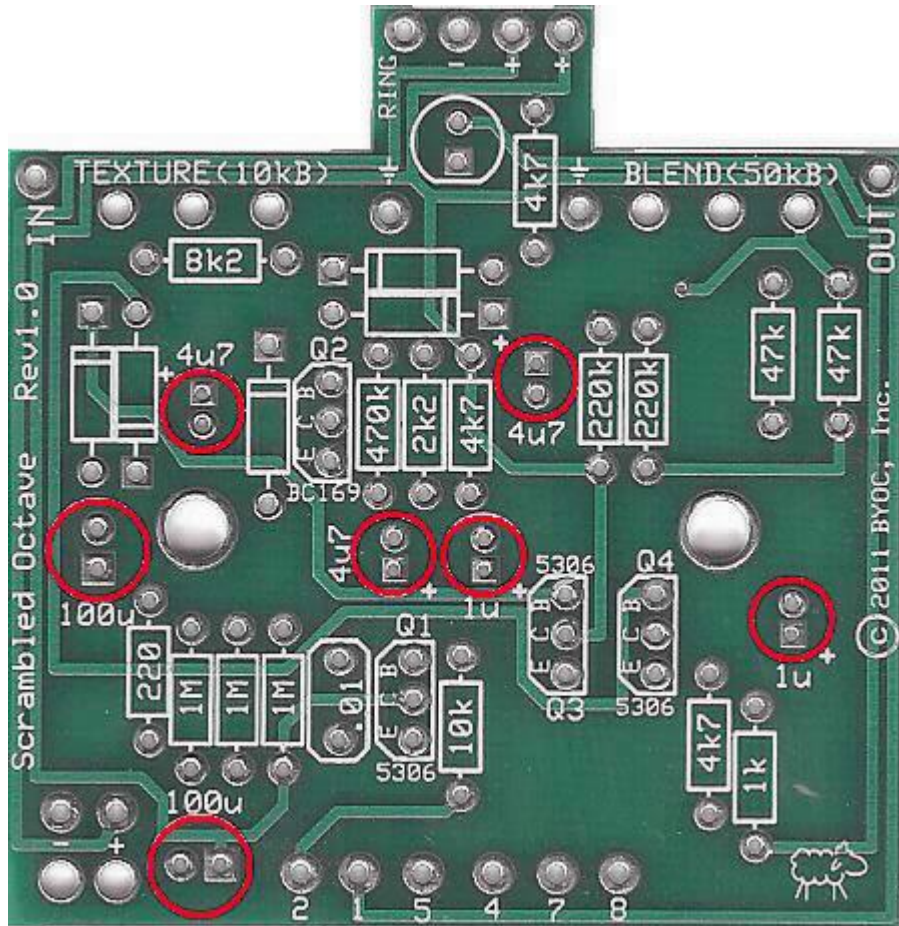

STEP 5: Add the aluminum electrolytic capacitors. These are polarized. The positive end will have a longer lead and should go in the square solder pad. The negative end will have a shorter lead with a black or white stripe running down the body of the capacitor.

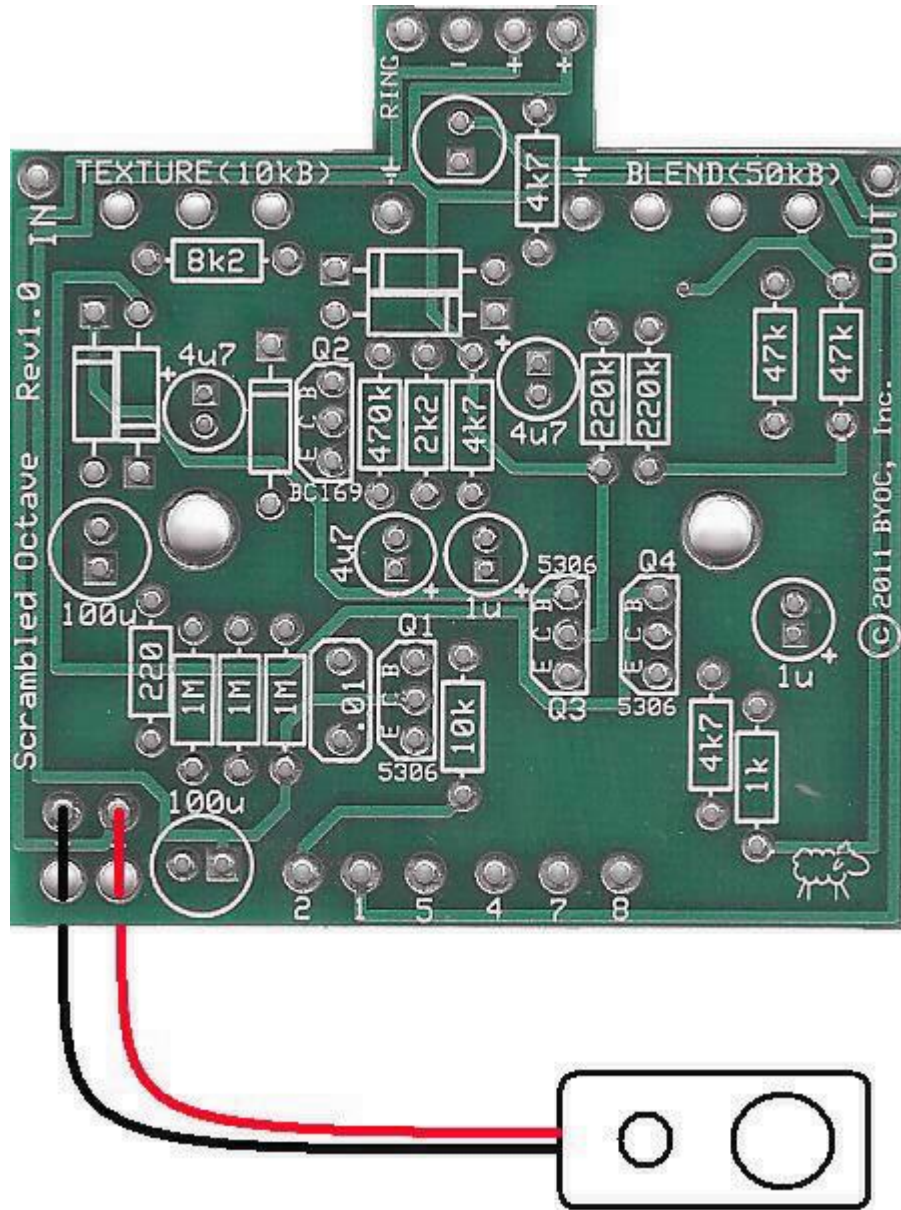

Step 6: Add the battery snap. Thread the solder ends of the battery snap into the strain relief holes from the bottom solderside of the PCB and out through the top. Insert the solder ends of the battery snap wires into the topside of their respective solder pads. Solder on the bottom side of the PCB. Remember the red wire goes in the “+” hole and the black wire goes in the “-” hole.

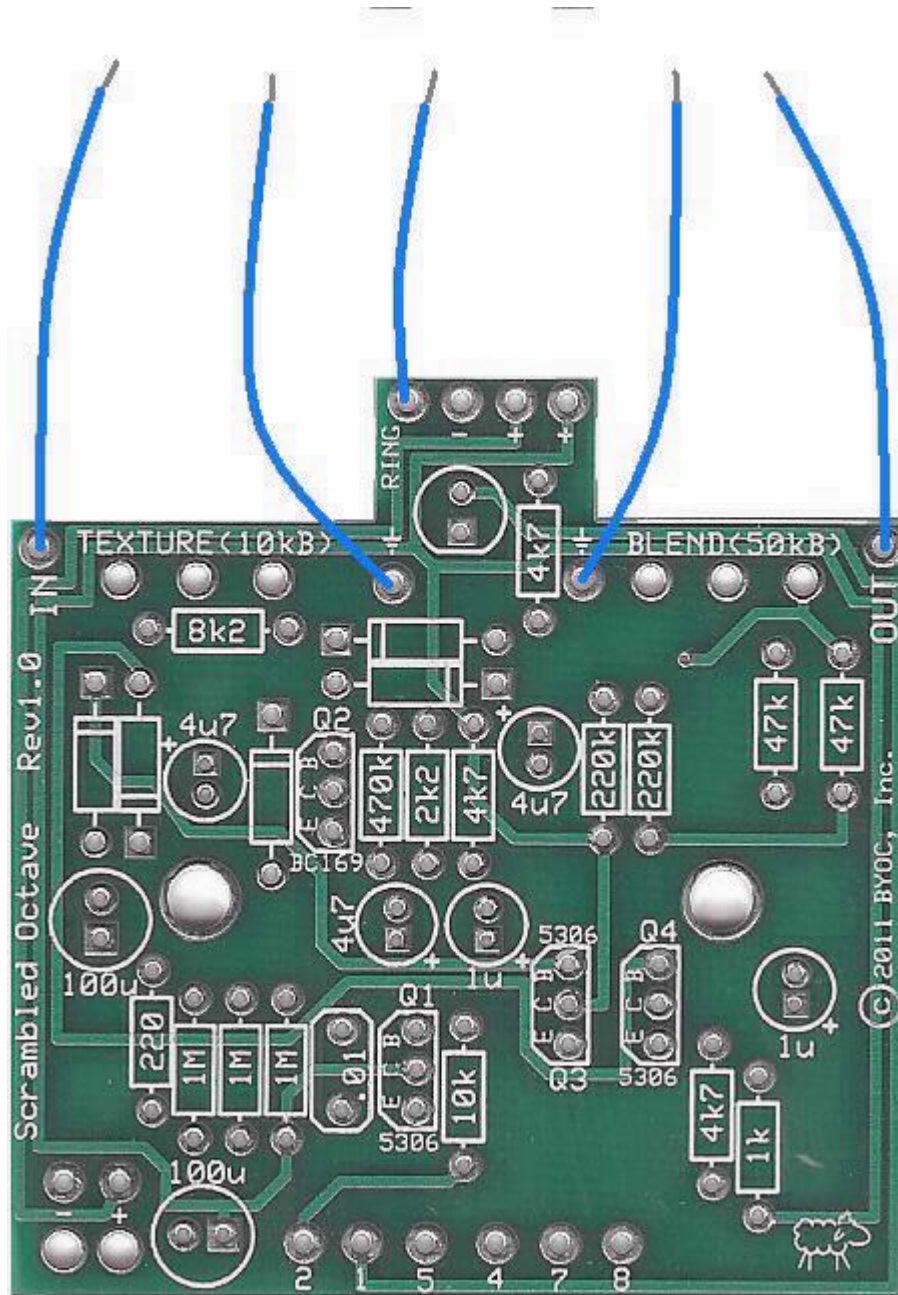

Step 7: Add wires to the IN, OUT, RING, and two Ground eyelets. Start by cutting four 2.5" pieces of wire and one 1.5" piece of wire. Strip 1/4" off each end and tin the ends.

Tinning means to apply some solder to the stripped ends of the wires. This keeps the strands from fraying and primes the wire for soldering. Solder a 2.5" piece of wire to each of the IN, OUT, and Ground eyelets on the PCB. Solder the 1.5" piece of wire to the RING eyelet on the PCB. Load the wires in from the top and solder on the bottom of the PCB.

# Main PCB Assembly

Below is a picture of an “internal nut” DC adapter jack with nylon nut. Your kit may come with a jack that looks like this, or it may come with an “external nut” jack with metal nut. Both have the exact same termination and both function identically. Internal nut jacks mount to the enclosure from the outside and the nut goes on the inside. External nut jacks mount from the inside and the nut goes on the outside.

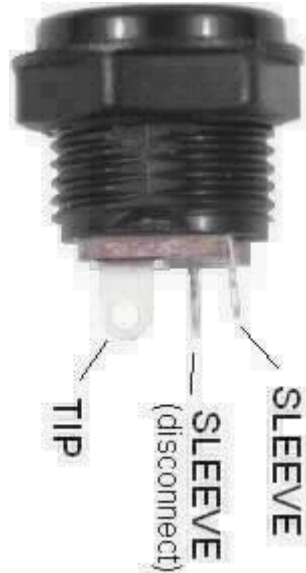

Step 1: Mount the DC adapter jack to the enclosure.

The sleeve disconnect terminal of the DC adapter jack connects directly to the positive terminal of the battery via the PCB. The sleeve disconnect terminal is connected to the sleeve terminal when there is no DC adapter plugged into the jack. When a DC adapter jack is plugged into the DC adapter jack, the connection between the sleeve disconnect terminal and the sleeve terminal is broken, thus disconnecting the battery from the circuit when a DC power supply is in use. This allows you to safely keep a battery in your pedal and still use a DC power supply.

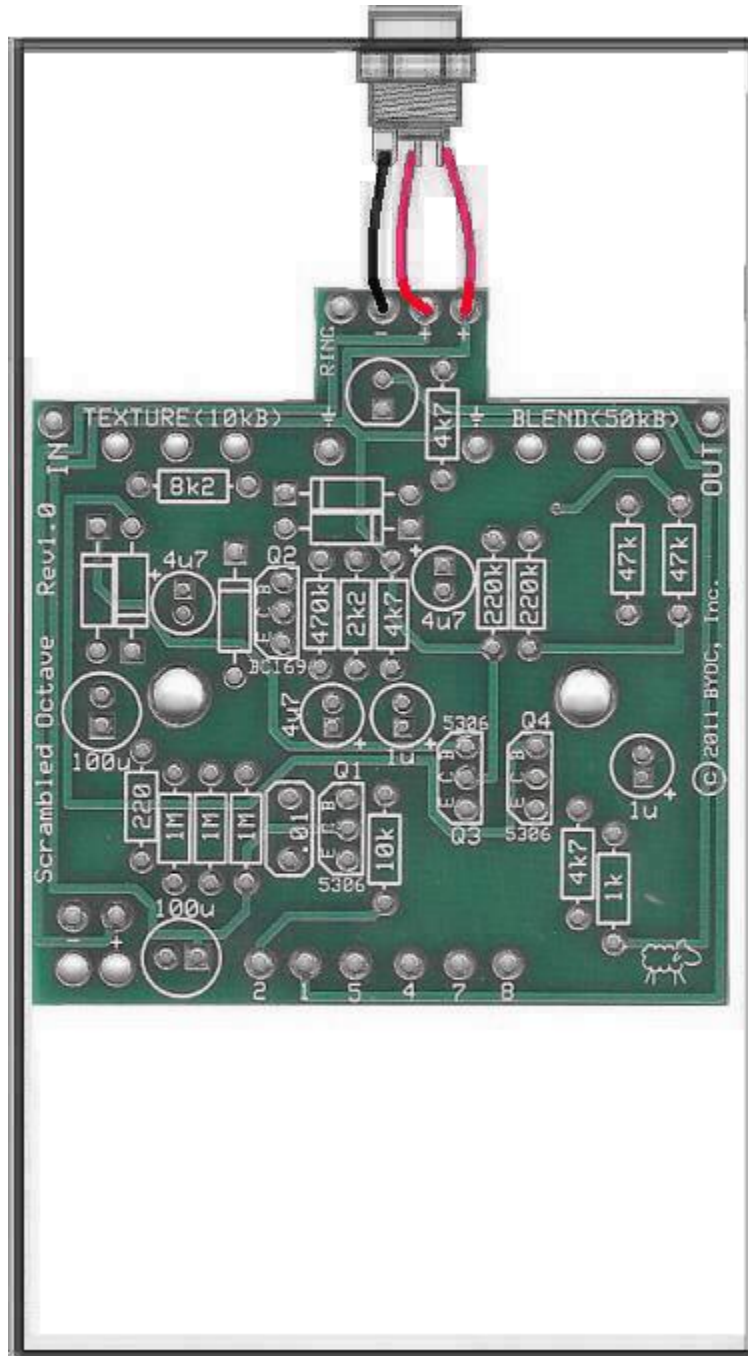

**Step 2:** Connect the TIP (negative) terminal of the DC adapter jack to the “-” eyelet on the PCB with 2 inches of hook up wire. Connect the SLEEVE of the DC adaptor jack to the “+” eyelet on the far right side of the PCB with 2 inches of hook up wire. Connect the battery disconnect terminal of the DC adaptor jack to the “+” eyelet more towards the center of the PCB with 2” of hookup wire. Load the wires in from the bottom of the PCB and solder on the topside.

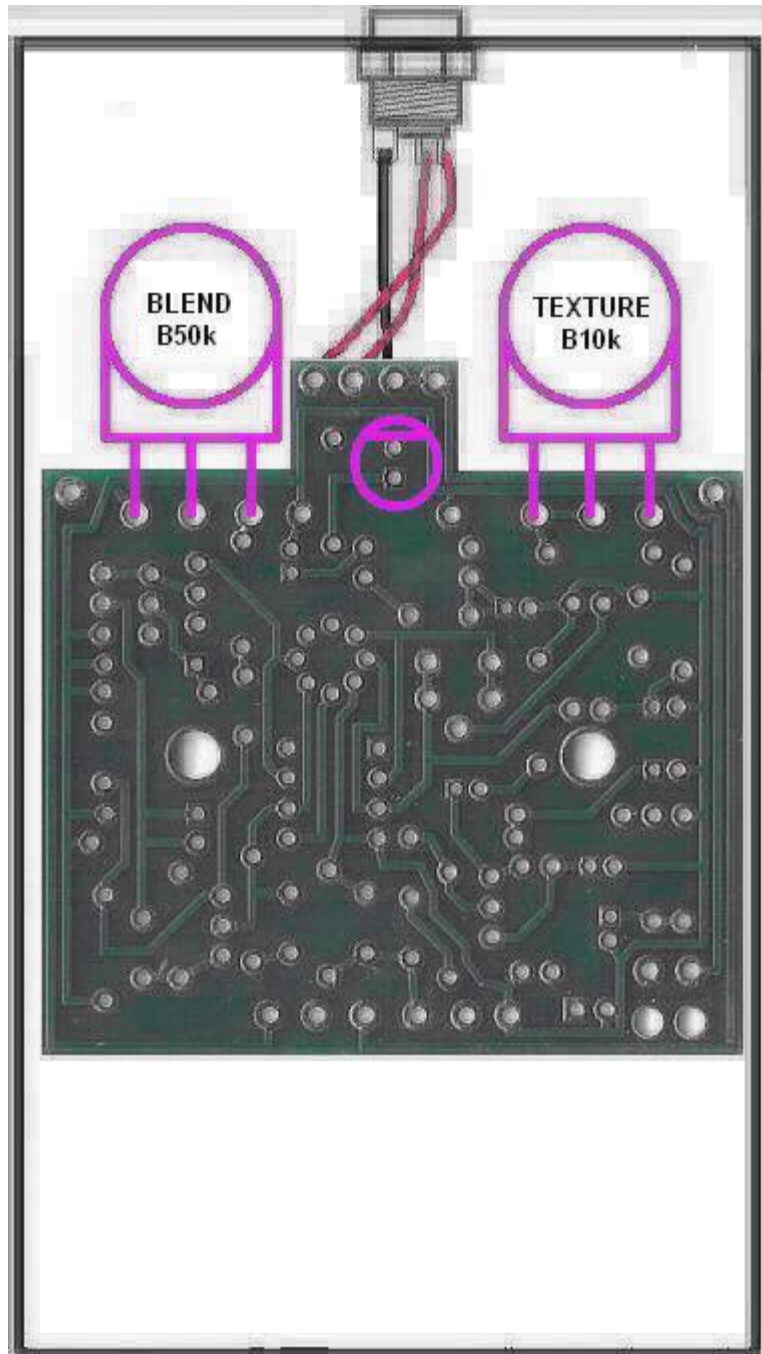

Step 3: Flip the PCB over so that the bottom or solder side is up. Insert the B10k(TEXTURE), B50k(BLEND) potentiometers, and the LED into the bottom side of the PCB. **DO NOT SOLDER ANYTHING YET!!!** The LED will have one lead that is longer than the other. The longer lead goes in the hole with the square solder pad.

Step 4: Hold the PCB in one hand so that the component side of the PCB is in the palm of your hand and the bottom side with the pots, toggle switch and LED is facing up. Now use your other hand to guide the predrilled enclosure onto the PCB assembly so that the

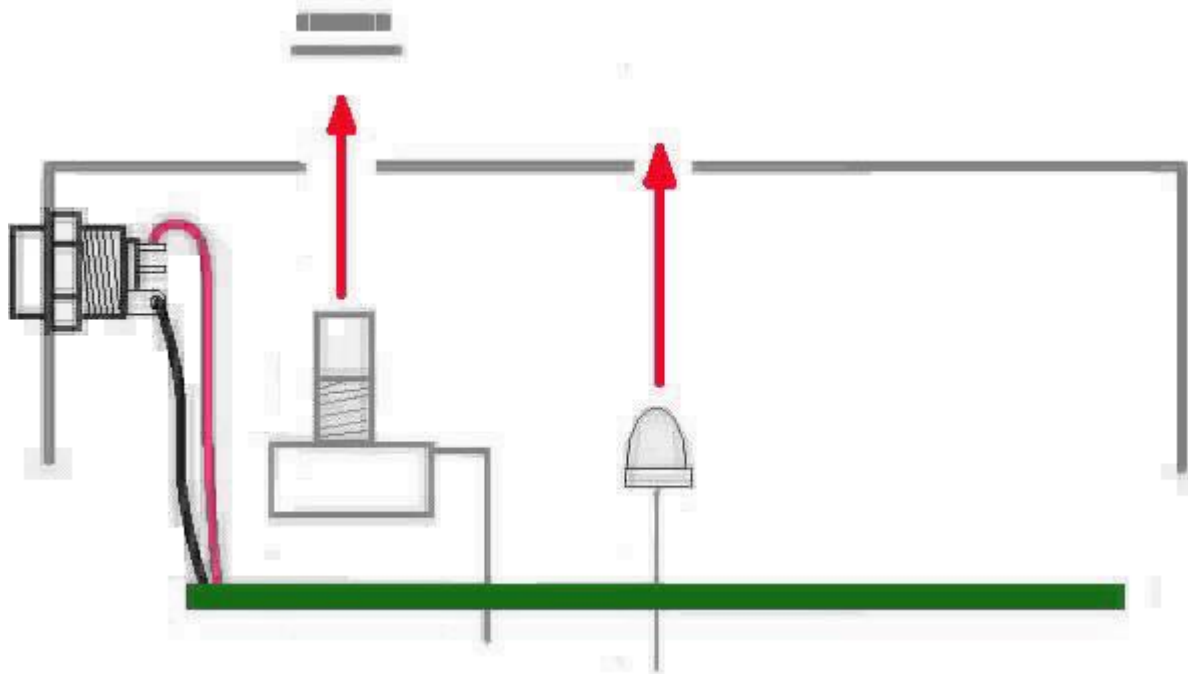

pots and LED all go into their respective holes. Once the PCB assembly is in place, secure it by screwing on the washers and nuts for the pots and toggle switch. Only tighten them with your fingers. You do not want them very tight yet. Be sure to keep your hand on the PCB so that it does not fall off the PC mounting posts of the pots and toggle switch.

Step 5: Turn the entire pedal over so that the component side of the PCB is facing up. Lift the PCB up off the pots and toggle switch about 2mm just to make sure that the back of the PCB does not short out against that pots. Make sure the PCB is level and symmetrically seated inside the enclosure.

Step 6: Solder the pots and LEDs. You will solder these parts on the component side of the PCB. After you have soldered them in place, be sure to tighten up their nuts.

# Wiring



Step 1: Install the 1/4" jacks to the enclosure.

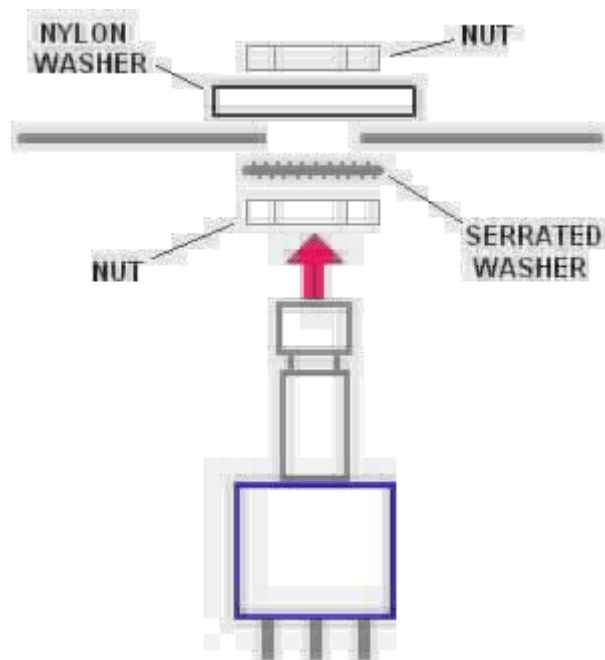

Step 2: Install the footswitch. Orient the footswitch so that the flat sides of the solder lugs are like the diagram below. NOTE: There are no actual number markings on the footswitch. There are two correct ways you can orient the footswitch. They are both 180 degrees of each other. Either way is fine. It does not matter as long as the flat sides of the solder lugs are running horizontal, not vertical.

### Footswitch Solder Lug Designations

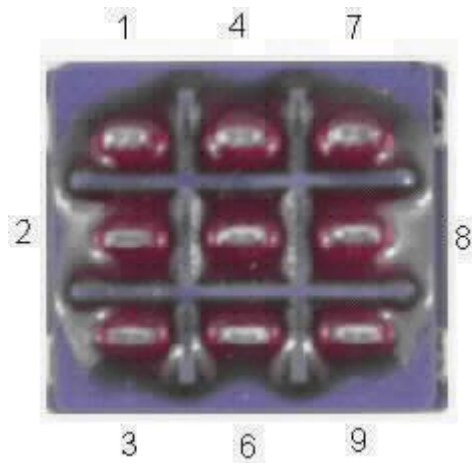
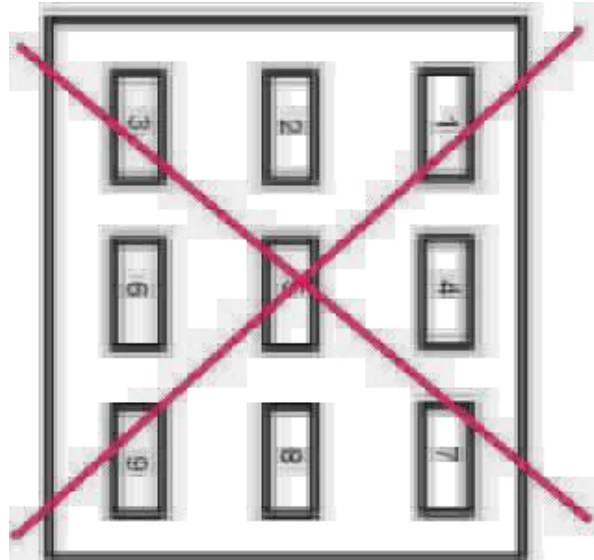
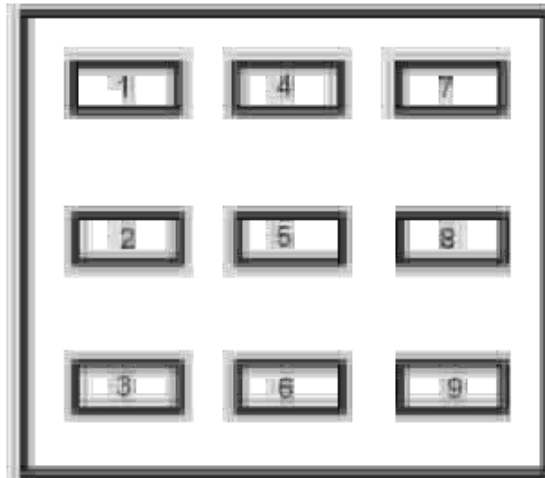

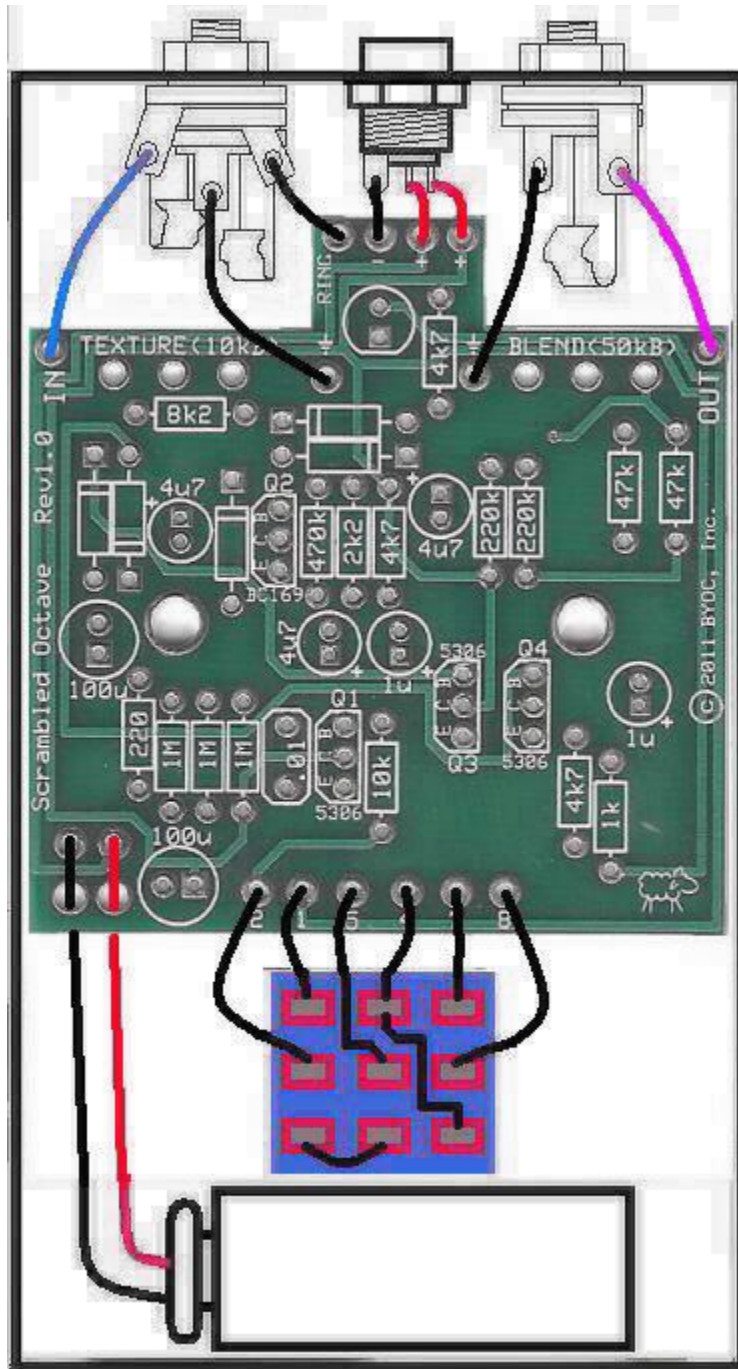

Step 3: Connect the pre stripped and tinned wires to the 1/4" jacks.

Step 4:

- Cut 4 x 3/4" pieces of wire. Strip 1/8" off each end. These will be used to connect lugs/eyelets 1, 2, 7, & 8
- Cut 1 x 1" piece of wire. Strip 1/8" off each end. This will be used to connect lug/eyelet 5
- Cut 1 x 1.5" peice of wire. Strip 1/8" of one end. Strip 1/2" off the other end. This will be used to connect lug/eyelet 4. The longer stripped end will be used to jumper lug 4 to 9.

- Cut 3 x 2" pieces of wire. Strip 1/4" off each end. These will be used to connect the tip and sleeve of the IN jack and the tip of the OUT jack to the PCB.
- Cut 1 x 1.5" peice of wire. Strip 1/4" off each end. This will be used to connect the ring of the IN jack to the ring eyelet on the PCB.

Step 5: Solder one end of the pre-cut and pre-stripped wires to the footswitch.

Step 6: Insert the other remaining ends of the pre-cut and pre-stripped wires into the topside of the PCB and solder. You can solder these on the topside as well. It is easier this way, but you may burn a small amount of the PVC coating on the wires. This is purely asthetic and won't damage the wires in anyway. But you can avoid this by removing the PCB assembly and footswitch from the enclosure entirely (the PCB assembly will still be attached to the enclosure via the DC jack wiring) so that you have access to solder the underside of the PCB.

# Operating Overview

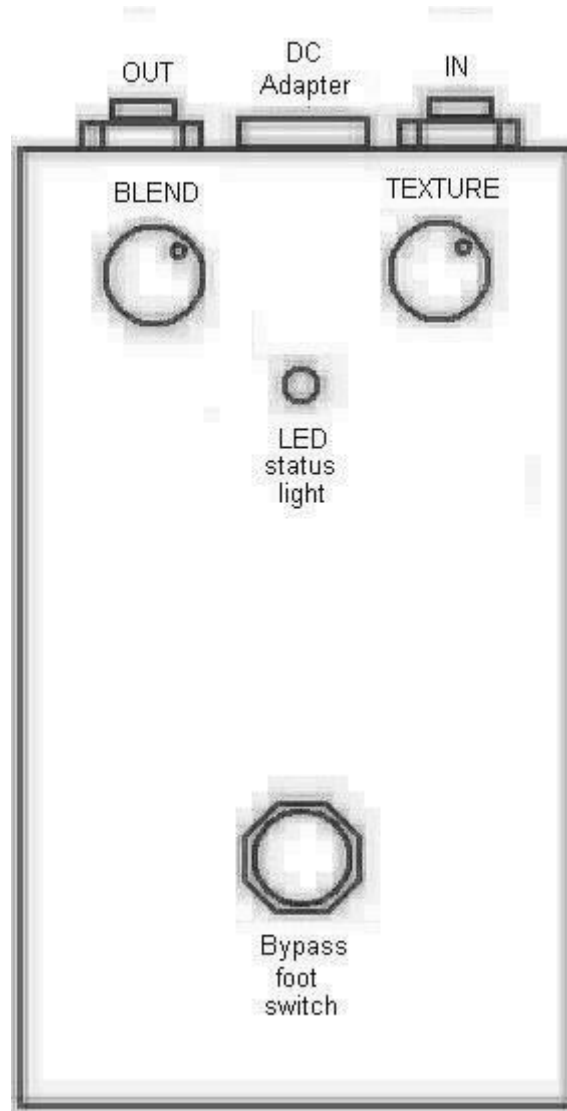

BLEND: Blends fuzz & octave with clean signal

TEXTURE: Controls the amount of octave

Power supply - Use a 2.5mm negative tip (this is your standard guitar fx style adapter) 9VDC adapter or a 9volt battery.

Current Draw - 4mA

Input Impedance - 1Meg ohms

Output Impedance - 30k ohms

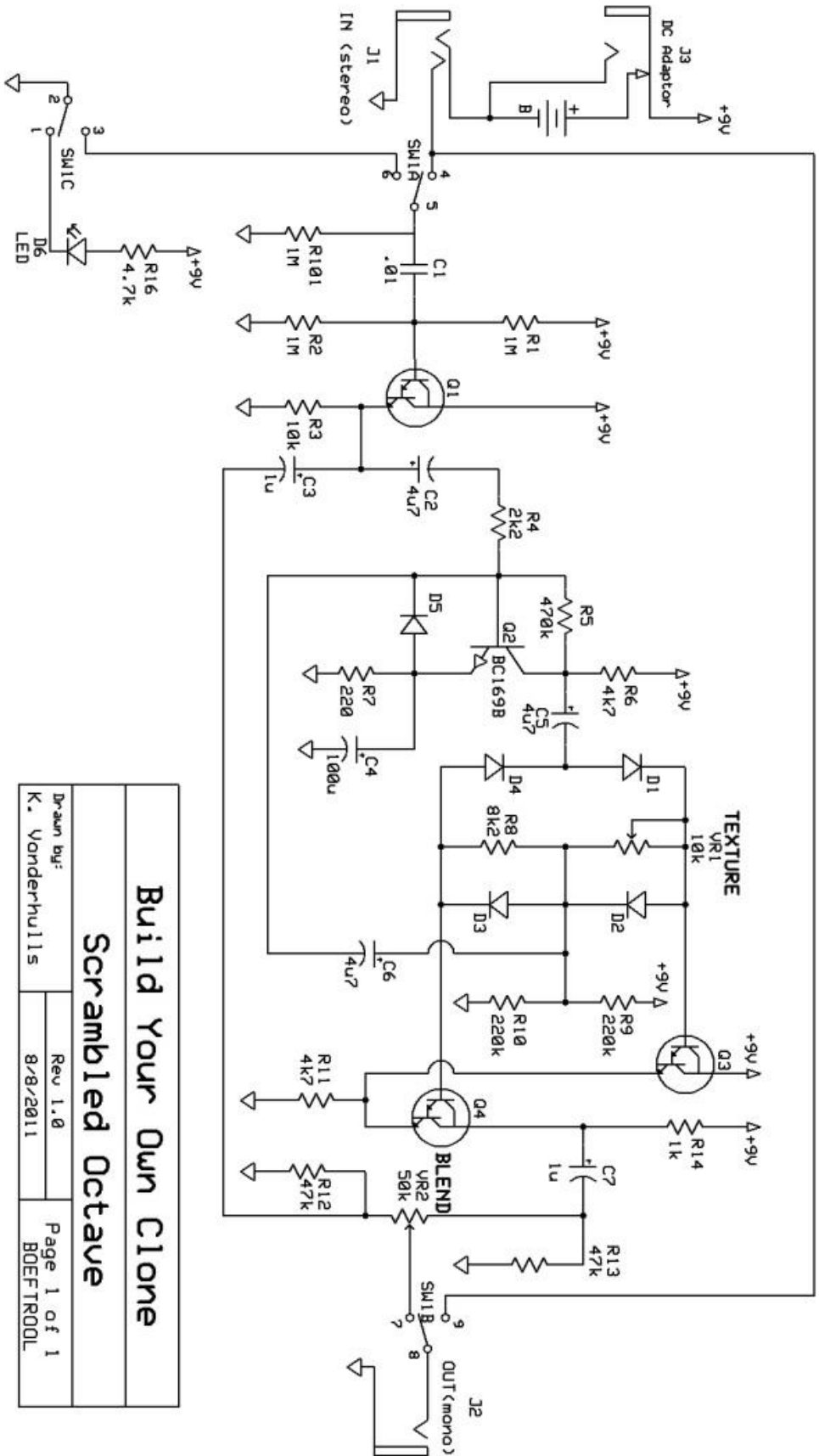

<b>Build Your Own Clone</b>	
<b>Scrambled Octave</b>	
Drawn by:	Rev 1.0
K. Vanderhullis	8/8/2011
Page 1 of 1	BOEFFTR00L

Please visit  
<http://buildyourownclone.com/board>  
for any technical support

[www.buildyourownclone.com/scrambledoctaveschematic.pdf](http://www.buildyourownclone.com/scrambledoctaveschematic.pdf)  
to download high res schematic.

copyright 2011  
B.Y.O.C., Inc.